

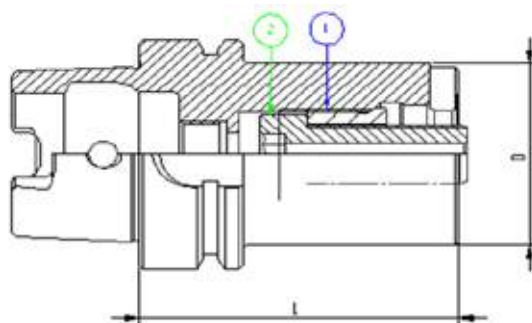

# HSK 63/A

## ATTACCHI BASE MODULARI



Codice	Descrizione	L	D
66AVL150	HSK63/A DIN69893 MODULARE H.80 D.50	80	50
66AVL163	HSK63/A DIN69893 MODULARE H.90 D.63	90	63

**COMPONENTI - SPARE PARTS - PIECES DETACHEES - ERSATZTEILE**

∅	VITE	Q.tà	GHIERA	Q.tà
				
	<b>1</b>		<b>2</b>	
50	111604011	1	122502007	1
63	112005011	1	123002408	1

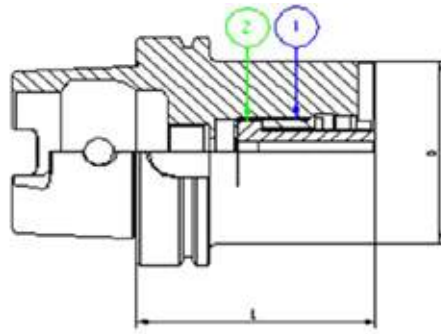

**HSK 100/A**

**ATTACCHI BASE MODULARI**



Codice	Descrizione	L	D
61AVL150	HSK100/A DIN69893 MODULARE H.85 D.50	85	50
61AVL163	HSK100/A DIN69893 MODULARE H.95 D.63	95	63
61AVL180	HSK100/A DIN69893 MODULARE H.95 D.80	95	80

**COMPONENTI - SPARE PARTS - PIECES DETACHEES - ERSATZTEILE**

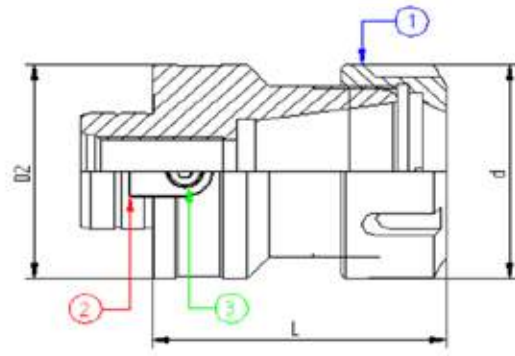

∅	Vite	Q.tà	Ghiera	Q.tà
				
	<b>1</b>		<b>2</b>	
50	111604011	1	122502007	1
63	112005011	1	123002408	1
80	112005011	1	123002408	1

# INSERTI MODULARI 50



Codice	Descrizione	D2	L	d
VL5PP113	MODULARE D50 P/PINZE ER20 H=63	50	63	35
VL5PP116	MODULARE D50 P/PINZE ER25 H=63	50	63	42
VL5PP120	MODULARE D50 P/PINZE ER32 H=65	50	65	50

**COMPONENTI - SPARE PARTS - PIECES DETACHEES - ERSATZTEILE**

ER	Ghiera	Q.tà	Tassello	Q.tà	Vite	Q.tà
						
20	920GHREQ	1	927TSL03	1	110401601	1
25	925GHREQ	1	927TSL03	1	110401601	1
32	932GHREQ	1	927TSL03	1	110401601	1

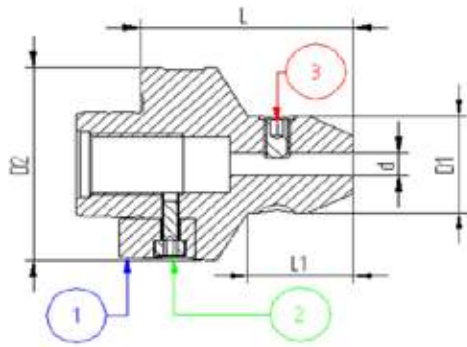

Codice	Descrizione	D2	L	d	L1	D1
VL5WLD06	MOD. D50 WELDON D.6 H=50	50	50	6	25	25
VL5WLD08	MOD. D50 WELDON D.8 H=50	50	50	8	25	28
VL5WLD10	MOD. D50 WELDON D.10 H=50	50	50	10	28	35
VL5WLD12	MOD. D50 WELDON D.12 H=60	50	60	12	36	42
VL5WLD14	MOD. D50 WELDON D.14 H=60	50	60	14	37	44
VL5WLD16	MOD. D50 WELDON D.16 H=60	50	60	16	39	48
VL5WLD18	MOD. D50 WELDON D.18 H=60	50	60	18	45	50
VL5WLD20	MOD. D50 WELDON D.20 H=62	50	62	20	47	52
VL5WLD25	MOD. D50 WELDON D.25 H=80	50	80	25	66	65

**COMPONENTI - SPARE PARTS - PIECES DETACHEES - ERSATZTEILE**

d	Tassello	Q.tà	Vite	Q.tà	Grano	Q.tà
6	927TSL03	1	110401201	1	100601002	1
8	927TSL03	1	110401201	1	100801002	1
10	927TSL03	1	110401201	1	101001202	1
12	927TSL03	1	110401201	1	101201602	1
14	927TSL03	1	110401201	1	101201602	1
16	927TSL03	1	110401201	1	101401602	1
18	927TSL03	1	110401201	1	101401602	1
20	927TSL03	1	110401201	1	101601602	1
25	927TSL03	1	110401201	1	101802002	2

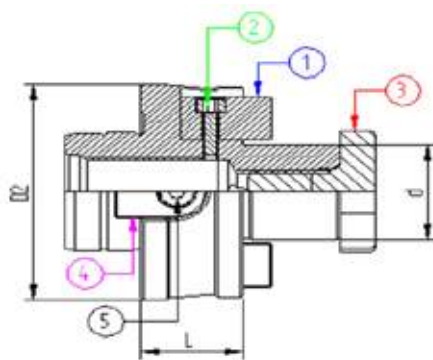

Codice	Descrizione	D2	L	d
VL5PF116	MODULARE D50 P/FRESA D.16 H=30	50	30	16
VL5PF122	MODULARE D50 P/FRESA D.22 H=20	50	20	22
VL5PF127	MODULARE D50 P/FRESA D.27 H=20	50	20	27
VL5PF132	MODULARE D50 P/FRESA D.32 H=25	50	25	32

**COMPONENTI - SPARE PARTS - PIECES DETACHEES - ERSATZTEILE**



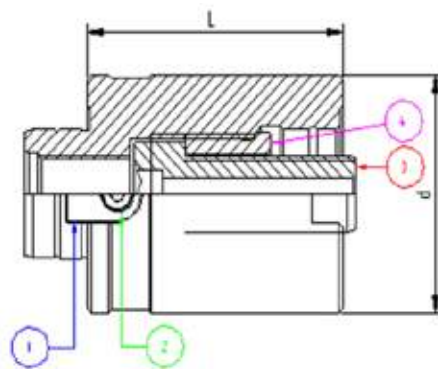

d	Tassello	Q.tà	Vite	Q.tà	Vite Croce	Q.tà	Tassello	Q.tà	Vite	Q.tà
16	916TSL01	2	110301001	2	916VTC02	1	927TSL03	1	110401201	1
22	922TSL01	2	110301001	2	922VTC02	1	927TSL03	1	110401201	1
27	927TSL01	2	110401601	2	927VTC02	1	927TSL03	1	110401201	1
32	932TSL01	2	110601601	2	932VTC02	1	927TSL03	1	110401201	1





Codice	Descrizione	L	d
VL5PR060	MODULARE D50 PROLUNGA H=60	60	50
VL5PR080	MODULARE D50 PROLUNGA H=80	80	50
VL5PR100	MODULARE D50 PROLUNGA H=100	100	50

**COMPONENTI - SPARE PARTS - PIECES DETACHEES - ERSATZTEILE**

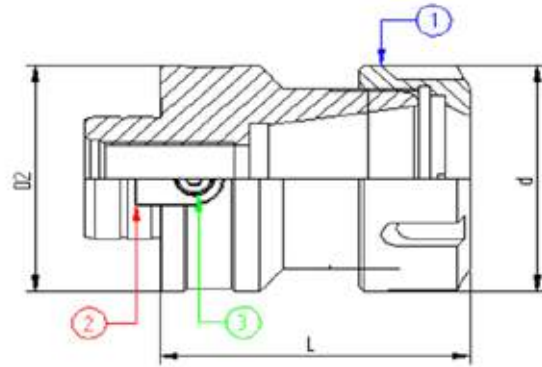

L	Tassello	Q.tà	Vite	Q.tà	Vite	Q.tà	Ghiera	Q.tà
								
	<b>1</b>		<b>2</b>		<b>3</b>		<b>4</b>	
60	927TSL03	1	111604011	1	110401201	1	122502007	1
80	927TSL03	1	111604011	1	110401201	1	122502007	1
100	927TSL03	1	111604011	1	110401201	1	122502007	1

# INSERTI MODULARI 63



Codice	Descrizione	D2	L	d
VL6PP120	MODULARE D63 P/PINZE ER32 H=77	63	77	50
VL6PP126	MODULARE D63 P/PINZE ER40 H=86	63	86	63

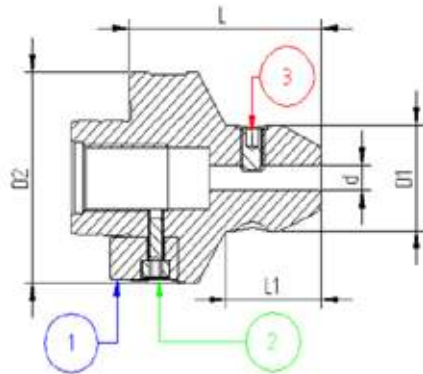

**COMPONENTI - SPARE PARTS - PIECES DETACHEES - ERSATZTEILE**

ER	Ghiera	Q.tà	Tassello	Q.tà	Vite	Q.tà
						
32	932GHREQ	1	940TSL06	1	110601201	1
40	940GHREQ	1	940TSL06	1	110601201	1



Codice	Descrizione	D2	L	d	L1	D1
VL6WLD10	MOD. D63 WELDON D.10 H=70	63	70	10	36	35
VL6WLD12	MOD. D63 WELDON D.12 H=70	63	70	12	39,5	42
VL6WLD14	MOD. D63 WELDON D.14 H=70	63	70	14	40,5	44
VL6WLD16	MOD. D63 WELDON D.16 H=70	63	70	16	42,5	48
VL6WLD18	MOD. D63 WELDON D.18 H=70	63	70	18	43,5	50
VL6WLD20	MOD. D63 WELDON D.20 H=70	63	70	20	44,5	52
VL6WLD25	MOD. D63 WELDON D.25 H=80	63	80	25	59,5	62
VL6WLD32	MOD. D63 WELDON D.32 H=80	63	80	32	64,5	63
VL6WLD40	MOD. D63 WELDON D.40 H=90	63	90	40	70	80

**COMPONENTI - SPARE PARTS - PIECES DETACHEES - ERSATZTEILE**

d	Tassello	Q.tà	Vite	Q.tà	Grano	Q.tà
						
	<b>1</b>		<b>2</b>		<b>3</b>	
10	940TSL06	1	110601201	1	101001202	1
12	940TSL06	1	110601201	1	101201602	1
14	940TSL06	1	110601201	1	101201602	1
16	940TSL06	1	110601201	1	101401602	1
18	940TSL06	1	110601201	1	101401602	1
20	940TSL06	1	110601201	1	101601602	1
25	940TSL06	1	110601201	1	101802002	2
32	940TSL06	1	110601201	1	102002002	2
40	940TSL06	1	110601201	1	102002002	2



ADATTATORE PORTA FRESA  
shell mill HOLDER ADAPTERS  
ADAPTATEURS PORTE FRAISES  
ADAPTER FUER FRAESER

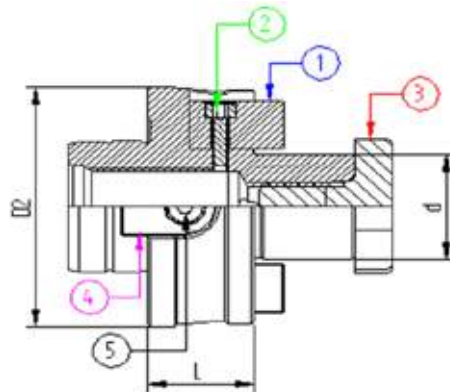

Codice	Descrizione	D2	L	d
VL6PF122	MODULARE D63 P/FRESA D.22 H=30	63	30	22
VL6PF127	MODULARE D63 P/FRESA D.27 H=30	63	30	27
VL6PF132	MODULARE D63 P/FRESA D.32 H=30	63	30	32
VL6PF140	MODULARE D63 P/FRESA D.40 H=30	63	30	40



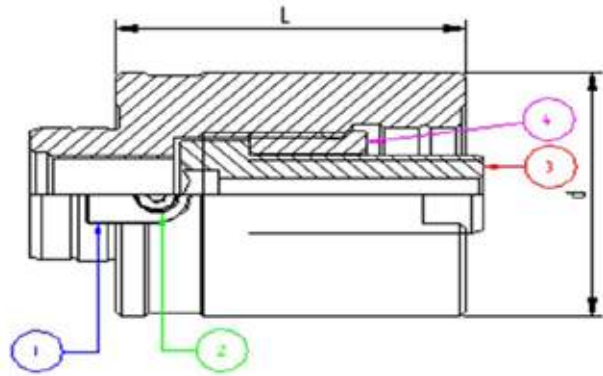

**COMPONENTI - SPARE PARTS - PIECES DETACHEES - ERSATZTEILE**

d	Tassello	Q.tà	Vite	Q.tà	Vite Croce	Q.tà	Tassello	Q.tà	Vite	Q.tà
22	922TSL01	2	110301201	2	922VTC02	1	940TSL06	1	110601201	1
27	927TSL01	2	110401601	2	927VTC02	1	940TSL06	1	110601201	1
32	932TSL01	2	110601601	2	932VTC02	1	940TSL06	1	110601201	1
40	940TSL01	2	110601601	2	940VTC02	1	940TSL06	1	110601201	1



Codice	Descrizione	L	d
VL6PR080	MODULARE D63 PROLUNGA H=80	80	63
VL6PR120	MODULARE D63 PROLUNGA H=120	120	63



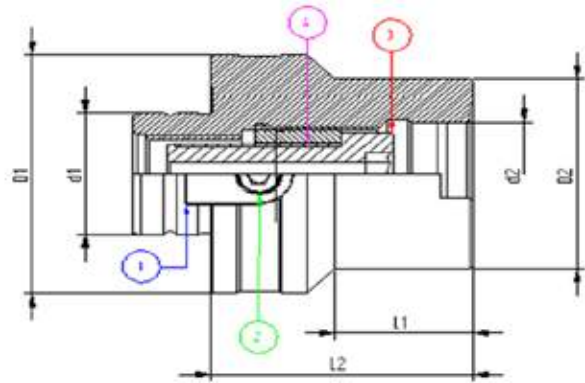

**COMPONENTI - SPARE PARTS - PIECES DETACHEES - ERSATZTEILE**

L	Tassello	Q.tà	Vite	Q.tà	Vite	Q.tà	Ghiera	Q.tà
								
	<b>1</b>		<b>2</b>		<b>3</b>		<b>4</b>	
80	940TSL06	1	110601201	1	112005012	1	123002408	1
120	940TSL06	1	110601201	1	112005012	1	123002408	1



Codice	Descrizione	D1	d1	L2	L1	d2	D2
VL6RD050	MODULARE D63 RIDUZIONE D.50 H=60	63	32	60	31,5	27	50

**COMPONENTI - SPARE PARTS - PIECES DETACHEES - ERSATZTEILE**

D	Tassello	Q.tà	Vite	Q.tà	Vite	Q.tà	Ghiera	Q.tà
								
50	940TSL03	1	110601201	1	111604011	1	122502007	1

# INSERTI MODULARI 80



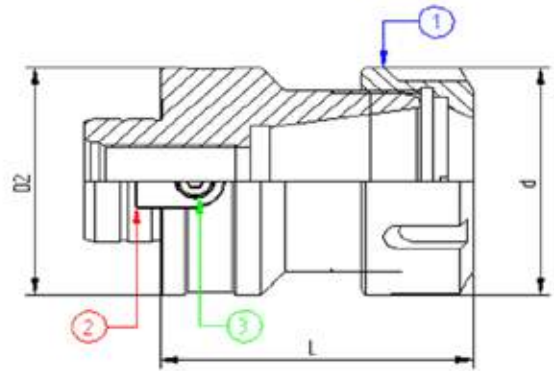

Codice	Descrizione	D2	L	d
VL8PP126	MODULARE D80 P/PINZE ER40 H=90	80	90	63

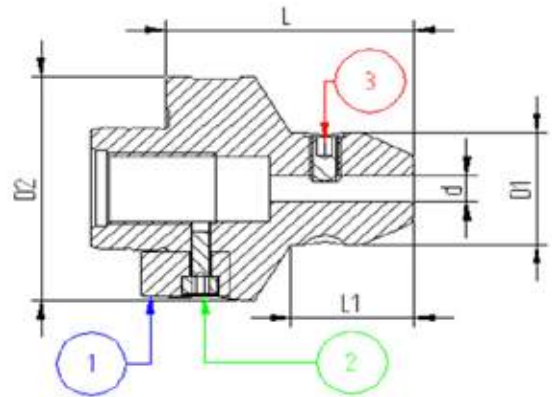

**COMPONENTI - SPARE PARTS - PIECES DETACHEES - ERSATZTEILE**

ER	Ghiera	Q.tà	Tassello	Q.tà	Vite	Q.tà
<b>1</b>						
40	940GHREQ	1	940TSL01	1	110601601	1



Codice	Descrizione	D2	L	d	L1	D1
VL8WLD16	MOD. D80 WELDON D.16 H=70	80	70	16	32	48
VL8WLD20	MOD. D80 WELDON D.20 H=70	80	70	20	34	52
VL8WLD25	MOD. D80 WELDON D.25 H=80	80	80	25	50,5	65
VL8WLD32	MOD. D80 WELDON D.32 H=80	80	80	32	54	72
VL8WLD40	MOD. D80 WELDON D.40 H=90	80	90	40	67,5	79



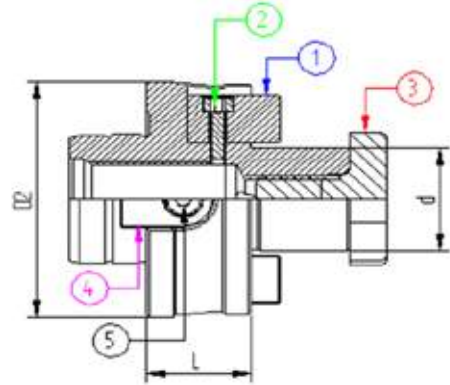

**COMPONENTI - SPARE PARTS - PIECES DETACHEES - ERSATZTEILE**

d	Tassello	Q.tà	Vite	Q.tà	Grano	Q.tà
						
	<b>1</b>		<b>2</b>		<b>3</b>	
16	940TSL01	1	110601601	1	101401602	1
20	940TSL01	1	110601601	1	101601602	1
25	940TSL01	1	110601601	1	101802002	2
32	940TSL01	1	110601601	1	102002002	2
40	940TSL01	1	110601601	1	102002002	2



Codice	Descrizione	D2	L	d
VL8PF127	MODULARE D80 P/FRESA D.27 H=30	80	30	27
VL8PF132	MODULARE D80 P/FRESA D.32 H=30	80	30	32
VL8PF140	MODULARE D80 P/FRESA D.40 H=30	80	30	40



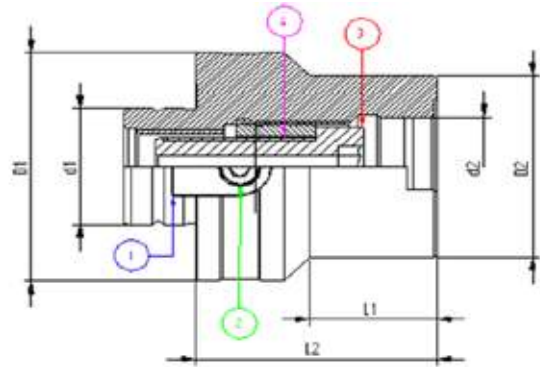

**COMPONENTI - SPARE PARTS - PIECES DETACHEES - ERSATZTEILE**

Ø	Tassello	Q.tà	Vite	Q.tà	Vite Croce	Q.tà	Tassello	Q.tà	Vite	Q.tà
										
	<b>1</b>		<b>2</b>		<b>3</b>		<b>4</b>		<b>5</b>	
27	927TSL01	2	110401201	2	927VTC02	1	940TSL01	1	110601601	1
32	932TSL01	2	110601601	2	932VTC02	1	940TSL01	1	110601601	1
40	940TSL01	2	110601601	2	940VTC02	1	940TSL01	1	110601601	1



Codice	Descrizione	D1	d1	L2	L1	d2	D2
VL8RD163	MODULARE D80 RIDUZIONE D.63 H=80	80	32	80	49,5	32	63



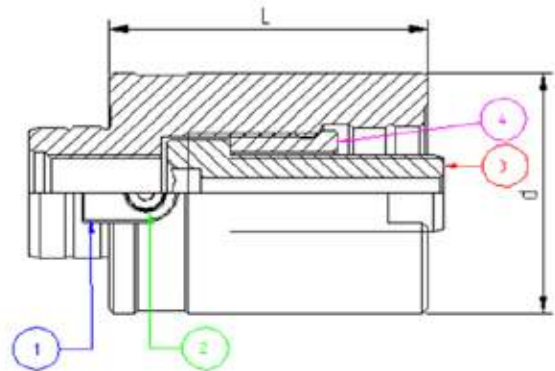

**COMPONENTI - SPARE PARTS - PIECES DETACHEES - ERSATZTEILE**

Ø	Vite	Q.tà	Ghiera	Q.tà	Vite	Q.tà	Tassello	Q.tà
								
63	112005011	1	123002408	1	110601601	1	940TSL01	1



Codice	Descrizione	L	d
VL8PR080	MODULARE D80 PROLUNGA H=80	80	80
VL8PR100	MODULARE D80 PROLUNGA H=100	100	80
VL8PR120	MODULARE D80 PROLUNGA H=120	120	80
VL8PR140	MODULARE D80 PROLUNGA H=140	140	80
VL8PR160	MODULARE D80 PROLUNGA H=160	160	80

**COMPONENTI - SPARE PARTS - PIÈCES DÉTACHÉES - ERSATZTEILE**

L	Tassello	Q.tà	Vite	Q.tà	Vite	Q.tà	Ghiera	Q.tà
								
80	940TSL01	1	110601601	1	112005011	1	123002408	1
100	940TSL01	1	110601601	1	112005011	1	123002408	1
120	940TSL01	1	110601601	1	112005011	1	123002408	1
140	940TSL01	1	110601601	1	112005011	1	123002408	1
160	940TSL01	1	110601601	1	112005011	1	123002408	1