

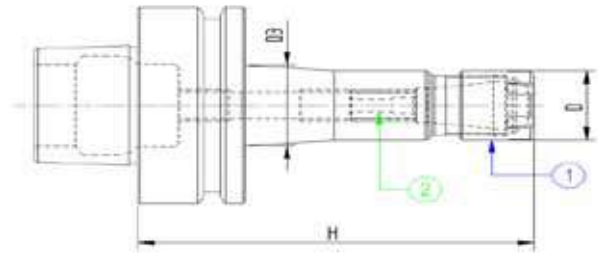

HSK 63/F



Codice	HSK	Descrizione	ER	H	D	D3	G2.5 20000
66FPM207	63/F	HSK63/F DIN69893 P/P H100 ER11MINI	11	100	16	20	●
66FPM210	63/F	HSK63/F DIN69893 P/P H100 ER16MINI	16	100	22	26	●
66FPM213	63/F	HSK63/F DIN69893 P/P H100 ER20MINI	20	100	28	32	●
66FPM216	63/F	HSK63/F DIN69893 P/P H100 ER25MINI	25	100	35	39	●

COMPONENTI - SPARE PARTS - PIECES DETACHEES - ERSATZTEILE

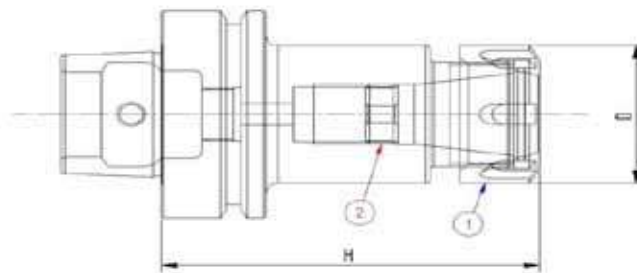

ER	Ghiera	Q.tà	Ghiera Interna	Q.tà
				
11	911GHRMN	1	100601004	1
16	916GHRMN	1	101001601	1
20	920GHRMN	1	101001601	1
25	925GHRMN	1	101815801	1



L=100

Codice	HSK	Descrizione	ER	D	H	G2.5 20000
66FPP210	63/F	HSK63/F DIN69893 P/P H100 ER16	16	32	100	●
66FPP213	63/F	HSK63/F DIN69893 P/P H100 ER20	20	35	100	●
66FPP216	63/F	HSK63/F DIN69893 P/P H100 ER25	25	42	100	●
66FPP220	63/F	HSK63/F DIN69893 P/P H100 ER32	32	50	100	●
66FPP226	63/F	HSK63/F DIN69893 P/P H100 ER40	40	63	100	●

COMPONENTI - SPARE PARTS - PIECES DETACHEES - ERSATZTEILE

ER	Ghiera	Q.tà	Ghiera Interna	Q.tà
				
16	916GHREQ	1	101001601	1
20	920GHREQ	1	101001601	1
25	925GHREQ	1	101815801	1
32	932GHREQ	1	102215901	1
40	940GHREQ	1	102215901	1

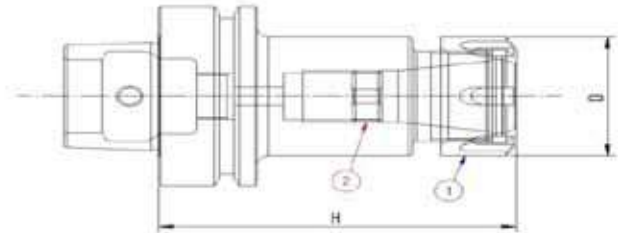

L=120

Codice	HSK	Descrizione	ER	D	H	G2.5 20000
66FPP310	63/F	HSK63/F DIN69893 P/P H120 ER16	16	32	120	●
66FPP313	63/F	HSK63/F DIN69893 P/P H120 ER20	20	35	120	●
66FPP316	63/F	HSK63/F DIN69893 P/P H120 ER25	25	42	120	●
66FPP320	63/F	HSK63/F DIN69893 P/P H120 ER32	32	50	120	●
66FPP326	63/F	HSK63/F DIN69893 P/P H120 ER40	40	63	120	●

L=160

Codice	HSK	Descrizione	ER	D	H	G2.5 20000
66FPP410	63/F	HSK63/F DIN69893 P/P H160 ER16	16	32	160	●
66FPP413	63/F	HSK63/F DIN69893 P/P H160 ER20	20	35	160	●
66FPP416	63/F	HSK63/F DIN69893 P/P H160 ER25	25	42	160	●
66FPP420	63/F	HSK63/F DIN69893 P/P H160 ER32	32	50	160	●
66FPP426	63/F	HSK63/F DIN69893 P/P H160 ER40	40	63	160	●

COMPONENTI - SPARE PARTS - PIECES DETACHEES - ERSATZTEILE

ER	Ghiera	Q.tà	Ghiera Interna	Q.tà
----	--------	------	----------------	------

1



2



16	916GHREQ	1	101001601	1
20	920GHREQ	1	101001601	1
25	925GHREQ	1	101815801	1
32	932GHREQ	1	102215901	1
40	940GHREQ	1	102215901	1

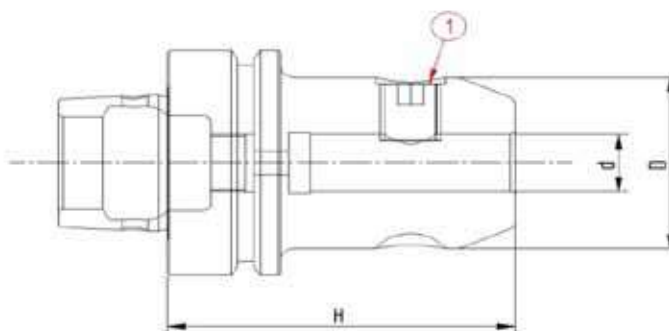

Codice	HSK	Descrizione	d	D	H	G2.5 20000
66FWLD06	63/F	HSK63/F DIN69893 WELDON H.65 D.6	6	25	65	●
66FWLD08	63/F	HSK63/F DIN69893 WELDON H.65 D.8	8	28	65	●
66FWLD10	63/F	HSK63/F DIN69893 WELDON H.65 D.10	10	35	65	●
66FWLD12	63/F	HSK63/F DIN69893 WELDON H.80 D.12	12	42	80	●
66FWLD14	63/F	HSK63/F DIN69893 WELDON H.80 D.14	14	44	80	●
66FWLD16	63/F	HSK63/F DIN69893 WELDON H.80 D.16	16	48	80	●
66FWLD18	63/F	HSK63/F DIN69893 WELDON H.80 D.18	18	50	80	●
66FWLD20	63/F	HSK63/F DIN69893 WELDON H.80 D.20	20	52	80	●
66FWLD25	63/F	HSK63/F DIN69893 WELDON H110 D25	25	65	110	●
66FWLD32	63/F	HSK63/F DIN69893 WELDON H110 D32	32	72	110	●

COMPONENTI - SPARE PARTS - PIECES DETACHEES - ERSATZTEILE

Ø WLD	Grano	Q.tà
-------	-------	------



6	100601002	1
8	100801002	1
10	101001202	1
12 - 14	101201602	1
16 - 18	101401602	1
20	101601602	1
25	101802002	2
32	102002002	2

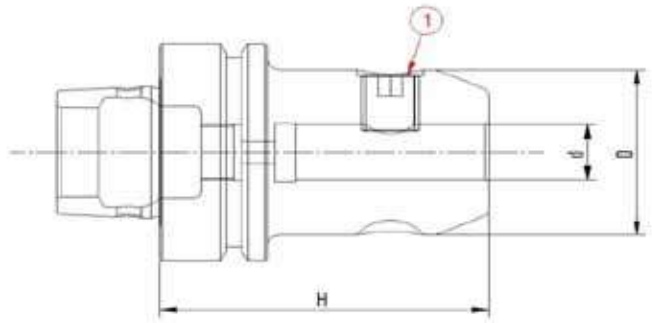

Codice	HSK	Descrizione	d	D	H	G2.5 20000
66FWE206	63/F	HSK63/F DIN69893 WELDON H100 D.6	6	25	100	●
66FWE208	63/F	HSK63/F DIN69893 WELDON H100 D.8	8	28	100	●
66FWE210	63/F	HSK63/F DIN69893 WELDON H100 D.10	10	35	100	●
66FWE212	63/F	HSK63/F DIN69893 WELDON H100 D.12	12	42	100	●
66FWE214	63/F	HSK63/F DIN69893 WELDON H100 D.14	14	44	100	●
66FWE216	63/F	HSK63/F DIN69893 WELDON H100 D.16	16	48	100	●
66FWE218	63/F	HSK63/F DIN69893 WELDON H100 D.18	18	50	100	●
66FWE220	63/F	HSK63/F DIN69893 WELDON H100 D.20	20	52	100	●

COMPONENTI - SPARE PARTS - PIECES DETACHEES - ERSATZTEILE

Ø WLD	Grano	Q.tà
-------	-------	------



6	100601002	1
8	100801002	1
10	101001202	1
12 - 14	101201602	1
16 - 18	101401602	1
20	101601602	1

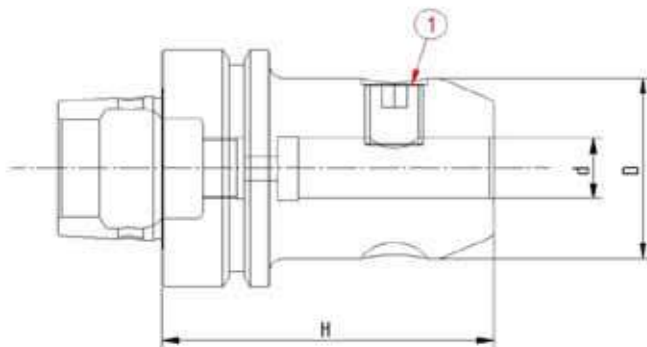

Codice	HSK	Descrizione	d	D	H	G2.5 20000
66FWE406	63/F	HSK63/F DIN69893 WELDON H.160 D.6	6	25	160	●
66FWE408	63/F	HSK63/F DIN69893 WELDON H.160 D.8	8	28	160	●
66FWE410	63/F	HSK63/F DIN69893 WELDON H.160 D.10	10	35	160	●
66FWE412	63/F	HSK63/F DIN69893 WELDON H.160 D.12	12	42	160	●
66FWE414	63/F	HSK63/F DIN69893 WELDON H.160 D.14	14	44	160	●
66FWE416	63/F	HSK63/F DIN69893 WELDON H.160 D.16	16	48	160	●
66FWE418	63/F	HSK63/F DIN69893 WELDON H.160 D.18	18	50	160	●
66FWE420	63/F	HSK63/F DIN69893 WELDON H.160 D.20	20	52	160	●
66FWE425	63/F	HSK63/F DIN69893 WELDON H.160 D.25	25	65	160	●
66FWE432	63/F	HSK63/F DIN69893 WELDON H.160 D.32	32	72	160	●
66FWE440	63/F	HSK63/F DIN69893 WELDON H.160 D.40	40	80	160	●

COMPONENTI - SPARE PARTS - PIECES DETACHEES - ERSATZTEILE

Ø WLD	Grano	Q.tà
-------	-------	------



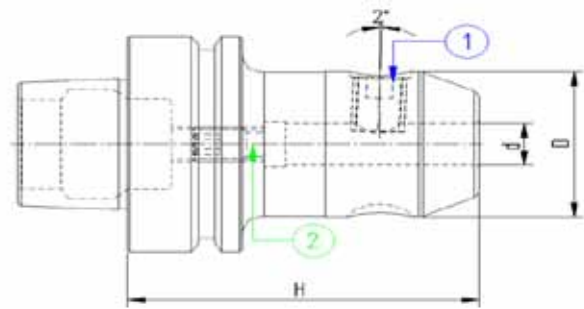

6	100601002	1
8	100801002	1
10	101001202	1
12 - 14	101201602	1
16 - 18	101401602	1
20	101601602	1
25	101802002	2
32 - 40	102002002	2



Codice	HSK	Descrizione	d	D	H	G2.5 20000
66FWHN06	63/F	HSK63/F DIN69893 W/NOTCH H80 D.06	6	25	80	●
66FWHN08	63/F	HSK63/F DIN69893 W/NOTCH H80 D.08	8	28	80	●
66FWHN10	63/F	HSK63/F DIN69893 W/NOTCH H80 D.10	10	35	80	●
66FWHN12	63/F	HSK63/F DIN69893 W/NOTCH H90 D.12	12	42	90	●
66FWHN14	63/F	HSK63/F DIN69893 W/NOTCH H90 D.14	14	44	90	●
66FWHN16	63/F	HSK63/F DIN69893 W/NOTCH H100 D.16	16	48	100	●
66FWHN18	63/F	HSK63/F DIN69893 W/NOTCH H100 D.18	18	50	100	●
66FWHN20	63/F	HSK63/F DIN69893 W/NOTCH H100 D.20	20	52	100	●
66FWHN25	63/F	HSK63/F DIN69893 W/NOTCH H110 D.25	25	65	110	●
66FWHN32	63/F	HSK63/F DIN69893 W/NOTCH H115 D.32	32	72	115	●

COMPONENTI - SPARE PARTS - PIECES DETACHEES - ERSATZTEILE

Ø WHN	Grano	Q.tà	Grano Interno	Q.tà
				
	1		2	
6	100601002	1	100501601	1
8	100801002	1	100601601	1
10	101001202	1	100801601	1
12 - 14	101201602	1	100801601	1
16 - 18	101401602	1	100801601	1
20	101601602	1	100801601	1
25	101802002	2	100801601	1
32	102002002	2	100801601	1

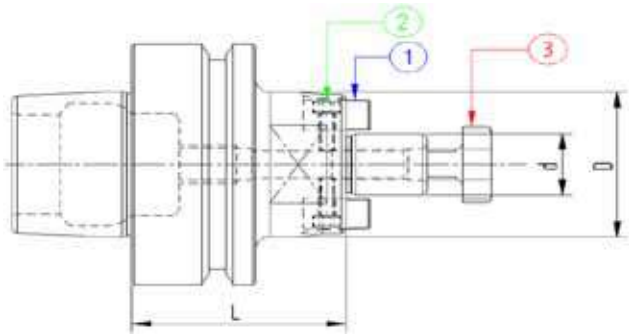



STANDARD

Codice	HSK	Descrizione	d	D	L	G2.5 20000
66FPF116	63/F	HSK63/F DIN69893 P/F FISSO H50 D16	16	38	50	●
66FPF122	63/F	HSK63/F DIN69893 P/F FISSO H50 D22	22	48	50	●
66FPF127	63/F	HSK63/F DIN69893 P/F FISSO H60 D27	27	58	60	●
66FPF132	63/F	HSK63/F DIN69893 P/F FISSO H60 D32	32	63	60	●
66FPF140	63/F	HSK63/F DIN69893 P/F FISSO H60 D40	40	80	60	●

L = 100

Codice	HSK	Descrizione	d	D	L	G2.5 20000
66FPF216	63/F	HSK63/F DIN69893 P/F FISSO H100 D16	16	38	100	●
66FPF222	63/F	HSK63/F DIN69893 P/F FISSO H100 D22	22	48	100	●
66FPF227	63/F	HSK63/F DIN69893 P/F FISSO H100 D27	27	58	100	●
66FPF232	63/F	HSK63/F DIN69893 P/F FISSO H100 D32	32	66	100	●
66FPF240	63/F	HSK63/F DIN69893 P/F FISSO H100 D40	40	80	100	●

COMPONENTI - SPARE PARTS - PIECES DETACHEES - ERSATZTEILE

d / D	Tassello	Q.tà	Vite Tassello	Q.tà	Vite a Croce	Q.tà
						
	1		2		3	
16 / 38	916TSL01	2	110301001	2	916VTC02	1
22 / 48	922TSL01	2	110301201	2	922VTC02	1
27 / 58	927TSL01	2	110401601	2	927VTC02	1
32 / 66	932TSL01	2	110601601	2	932VTC02	1
40 / 80	940TSL01	2	110601601	2	940VTC02	1

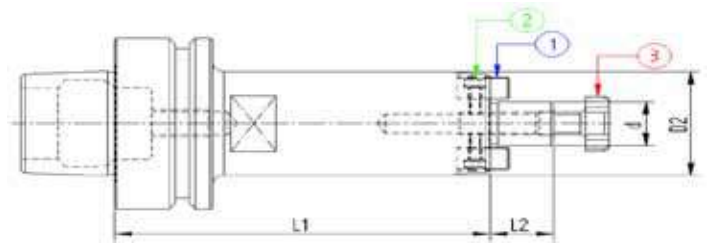



L = 130

Codice	HSK	Descrizione	d	D	L1	L2	G2.5 20000
66FPF316	63/F	HSK63/F DIN69893 P/F FISSO H130 D16	16	38	130	17	●
66FPF322	63/F	HSK63/F DIN69893 P/F FISSO H130 D22	22	40	130	19	●
66FPF327	63/F	HSK63/F DIN69893 P/F FISSO H130 D27	27	58	130	21	●
66FPF332	63/F	HSK63/F DIN69893 P/F FISSO H130 D32	32	66	130	24	●
66FPF340	63/F	HSK63/F DIN69893 P/F FISSO H130 D40	40	80	130	27	●

L = 160

Codice	HSK	Descrizione	d	D	L1	L2	G2.5 20000
66FPF416	63/F	HSK63/F DIN69893 P/F FISSO H160 D16	16	38	160	17	●
66FPF422	63/F	HSK63/F DIN69893 P/F FISSO H160 D22	22	48	160	19	●
66FPF427	63/F	HSK63/F DIN69893 P/F FISSO H160 D27	27	58	160	21	●
66FPF432	63/F	HSK63/F DIN69893 P/F FISSO H160 D32	32	66	160	24	●
66FPF440	63/F	HSK63/F DIN69893 P/F FISSO H160 D40	40	80	160	27	●

COMPONENTI - SPARE PARTS - PIECES DETACHEES - ERSATZTEILE

d / D	Tassello	Q.tà	Vite Tassello	Q.tà	Vite a Croce	Q.tà
						
	1		2		3	
16 / 38	916TSL01	2	110301001	2	916VTC02	1
22 / 48	922TSL01	2	110301201	2	922VTC02	1
27 / 58	927TSL01	2	110401601	2	927VTC02	1
32 / 66	932TSL01	2	110601601	2	932VTC02	1
40 / 80	940TSL01	2	110601601	2	940VTC02	1

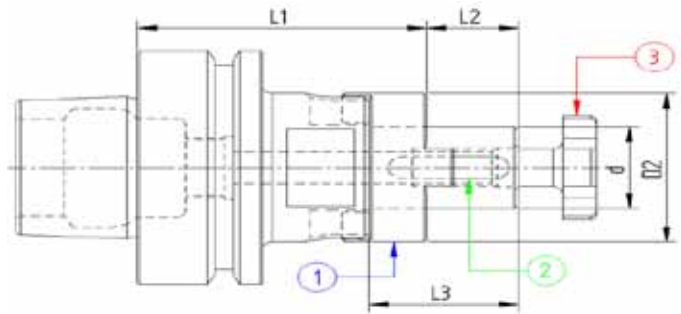



STANDARD

Codice	HSK	Descrizione	d	L1	L2	L3	D2
66FPU116	63/F	HSK63/F DIN69893 P/F UNIV.H60 D16	16	60	17	27	32
66FPU122	63/F	HSK63/F DIN69893 P/F UNIV.H60 D22	22	60	19	31	40
66FPU127	63/F	HSK63/F DIN69893 P/F UNIV.H60 D27	27	60	21	33	48
66FPU132	63/F	HSK63/F DIN69893 P/F UNIV.H60 D32	32	60	24	38	58
66FPU140	63/F	HSK63/F DIN69893 P/F UNIV.H70 D40	40	70	27	41	70

L = 160

Codice	HSK	Descrizione	d	L1	L2	L3	D2
66FPU416	63/F	HSK63/F DIN69893 P/F UNIV.H160 D16	16	160	17	27	32
66FPU422	63/F	HSK63/F DIN69893 P/F UNIV.H160 D22	22	160	19	31	40
66FPU427	63/F	HSK63/F DIN69893 P/F UNIV.H160 D27	27	160	21	33	48
66FPU432	63/F	HSK63/F DIN69893 P/F UNIV.H160 D32	32	160	24	38	58
66FPU440	63/F	HSK63/F DIN69893 P/F UNIV.H160 D40	40	160	27	41	70

COMPONENTI - SPARE PARTS - PIECES DETACHEES - ERSATZTEILE

d	Distanziale	Q.tà	Linguetta	Q.tà	Vite a Croce	Q.tà
						
16	916GNT01	1	170402004	1	916VTC02	1
22	922GNT01	1	170602506	1	922VTC02	1
27	927GNT01	1	170702507	1	927VTC02	1
32	932GNT01	1	170802807	1	932VTC02	1
40	940GNT01	1	171003208	1	940VTC02	1



MANDRINI ATTACCO CONO MORSE PER PUNTE
MORSE TAPER ADAPTORS FOR DRILL
DOUILLES POUR CONE MORSE A TENON
ZWISCHENHULSEN FUER MORSEKEGEL MIT AUSTREIBLAPPEN

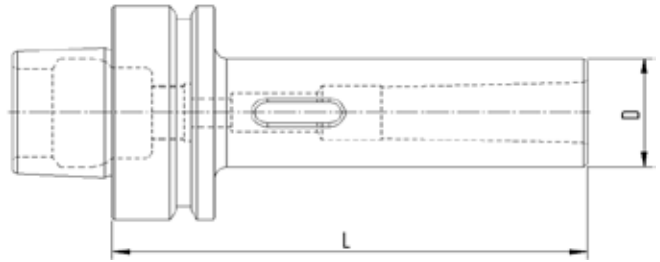

DIN 69893
DIN 228 - 2



Codice	HSK	Descrizione	MORSE	D	L
66FMP101	63/F	HSK63/F DIN69893 H.100 CM1 PUNTE	1	25	100
66FMP102	63/F	HSK63/F DIN69893 H.120 CM2 PUNTE	2	32	120
66FMP103	63/F	HSK63/F DIN69893 H.140 CM3 PUNTE	3	40	140
66FMP104	63/F	HSK63/F DIN69893 H.165 CM4 PUNTE	4	48	165

MANDRINI ATTACCO CONO MORSE PER FRESE
MORSE TAPER ADAPTER WITH THREAD
DOUILLES POUR CONE MORSE AVEC TARAUDAGE
ZWISCHENHULSEN FUER MORSEKEGEL MIT ANZUGSGEWINDE



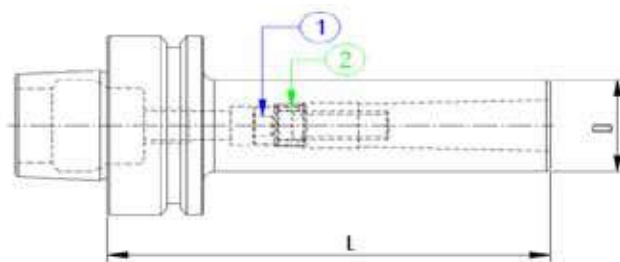

DIN 69893
DIN 228 - 2



Codice	HSK	Descrizione	MORSE	D	L
66FMF101	63/F	HSK63/F DIN69893 H.100 CM1 FRESE	1	25	100
66FMF102	63/F	HSK63/F DIN69893 H.120 CM2 FRESE	2	32	120
66FMF103	63/F	HSK63/F DIN69893 H.140 CM3 FRESE	3	40	140
66FMF104	63/F	HSK63/F DIN69893 H.160 CM4 FRESE	4	48	160

COMPONENTI - SPARE PARTS - PIECES DETACHEES - ERSATZTEILE

CM	Vite	Q.tà	Ghiera Interna	Q.tà
				
1	110603501	1	-	-
2	111003014	1	121500802	1
3	111204016	1	122000903	1
4	111604516	1	122501204	1

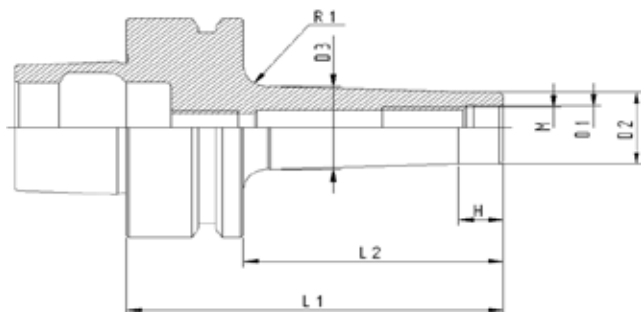

STANDARD

Codice	Descrizione	D1	D2	D3	H	L1	L2	M	G2.5 20000
66FAF106	HSK63/F DIN69893 P/F AT.FIL.M6x59	6.5	9.7	9.7	33	59	33	M6	●
66FAF108	HSK63/F DIN69893 P/F AT.FIL.M8x59	8.5	13	15	10	59	33	M8	●
66FAF110	HSK63/F DIN69893 P/F AT.FIL.M10x59	10.5	18	20	10	59	33	M10	●
66FAF112	HSK63/F DIN69893 P/F AT.FIL.M12x59	12.5	21	24	10	59	33	M12	●
66FAF116	HSK63/F DIN69893 P/F AT.FIL.M16x59	17.0	29	34	10	59	33	M16	●

L = 84

Codice	Descrizione	D1	D2	D3	H	L1	L2	M	G2.5 20000
66FAF206	HSK63/F DIN69893 P/F AT.FIL.M6x84	6.5	9.7	20	10	84	58	M6	●
66FAF208	HSK63/F DIN69893 P/F AT.FIL.M8x84	8.5	13	23	10	84	58	M8	●
66FAF210	HSK63/F DIN69893 P/F AT.FIL.M10x84	10.5	18	25	10	84	58	M10	●
66FAF212	HSK63/F DIN69893 P/F AT.FIL.M12x84	12.5	21	24	10	84	58	M12	●
66FAF216	HSK63/F DIN69893 P/F AT.FIL.M16x84	17.0	29	34	10	84	58	M16	●

L = 109

Codice	Descrizione	D1	D2	D3	H	L1	L2	M	G2.5 20000
66FAF306	HSK63/F DIN69893 P/F AT.FIL.M6x109	6.5	9.7	23	10	109	83	M6	●
66FAF308	HSK63/F DIN69893 P/F AT.FIL.M8x109	8.5	13	23	10	109	83	M8	●
66FAF310	HSK63/F DIN69893 P/F AT.FIL.M10x109	10.5	18	28	10	109	83	M10	●
66FAF312	HSK63/F DIN69893 P/F AT.FIL.M12x109	12.5	21	31	10	109	83	M12	●
66FAF316	HSK63/F DIN69893 P/F AT.FIL.M16x109	17.0	29	34	10	109	83	M16	●

L = 134

Codice	Descrizione	D1	D2	D3	H	L1	L2	M	G2.5 20000
66FAF408	HSK63/F DIN69893 P/F AT.FIL.M8x134	8.5	13	25	10	134	108	M8	●
66FAF410	HSK63/F DIN69893 P/F AT.FIL.M10x134	10.5	18	30	10	134	108	M10	●
66FAF412	HSK63/F DIN69893 P/F AT.FIL.M12x134	12.5	21	31	10	134	108	M12	●
66FAF416	HSK63/F DIN69893 P/F AT.FIL.M16x134	17.0	29	39	10	134	108	M16	●

MANDRINI SEMILAVORATI A STELO TENERO
BLANK TOOLHOLDER WITH SOFT SHANK
BARRES D'ALEPAGE SEMI-FINIES
ROHLINGE MIT WEICHEM SCHAFT



DIN 69893



Codice	HSK	Descrizione	D	L
66FST263	63/F	HSK63/F DIN69893 ST.TENERO D.63x200	63	200
66FST380	63/F	HSK63/F DIN69893 ST.TENERO D.80x250	80	250