

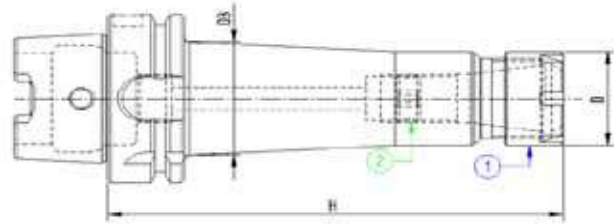

HSK 63/A



Codice	HSK	Descrizione	ER	D	H	D3	G6.3 15000
66APM107	63/A	HSK63/A DIN69893 P/P H80 ER11MINI	11	16	80	-	●
66APM207	63/A	HSK63/A DIN69893 P/P H100 ER11MINI	11	16	100	20	●
66APM210	63/A	HSK63/A DIN69893 P/P H100 ER16MINI	16	22	100	25	●
66APM213	63/A	HSK63/A DIN69893 P/P H100 ER20MINI	20	28	100	31	●
66APM216	63/A	HSK63/A DIN69893 P/P H100 ER25MINI	25	35	100	38	●
66APM407	63/A	HSK63/A DIN69893 P/P H160 ER11MINI	11	16	160	23	●
66APM410	63/A	HSK63/A DIN69893 P/P H160 ER16MINI	16	22	160	28	●
66APM413	63/A	HSK63/A DIN69893 P/P H160 ER20MINI	20	28	160	35	●
66APM416	63/A	HSK63/A DIN69893 P/P H160 ER25MINI	25	35	160	42	●

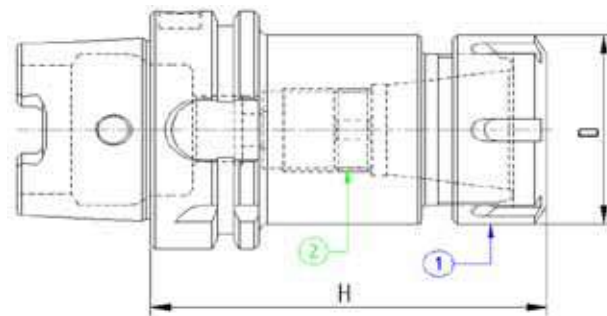

### COMPONENTI - SPARE PARTS - PIECES DETACHEES - ERSATZTEILE

ER	Ghiera	Q.tà	Ghiera Interna	Q.tà
				
	<b>1</b>		<b>2</b>	
11	911GHRMN	1	100601004	1
16	916GHRMN	1	101001601	1
20	920GHRMN	1	101001601	1
25	925GHRMN	1	101815801	1



Codice	HSK	Descrizione	ER	D	H	G6.3 15000
66APP110	63/A	HSK63/A DIN69893 P/P H75 ER16	16	32	75	●
66APP113	63/A	HSK63/A DIN69893 P/P H75 ER20	20	35	75	●
66APP116	63/A	HSK63/A DIN69893 P/P H75 ER25	25	42	75	●
66APP120	63/A	HSK63/A DIN69893 P/P H75 ER32	32	50	75	●
66APP126	63/A	HSK63/A DIN69893 P/P H80 ER40	40	63	80	●

### COMPONENTI - SPARE PARTS - PIECES DETACHEES - ERSATZTEILE

ER	Ghiera	Q.tà	Ghiera Interna	Q.tà
				
	<b>1</b>		<b>2</b>	
16	916GHREQ	1	101001601	1
20	920GHREQ	1	101001601	1
25	925GHREQ	1	101815801	1
32	932GHREQ	1	-	-
40	940GHREQ	1	-	-



MANDRINI PORTAPINZA TIPO ER  
ER COLLET CHUCK  
MANDRINS A PINCES TYPE ER  
SPANNZANGENFUTTER ER



**DIN 69893**

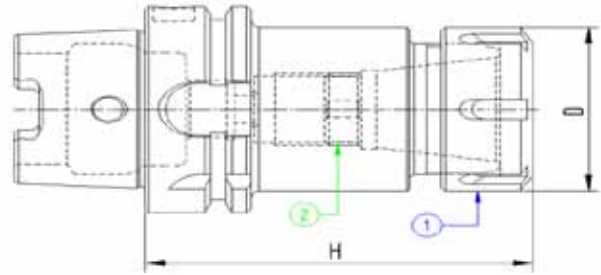

**DIN 6499**



**L=100**

Codice	HSK	Descrizione	ER	D	H	G6.3 15000
66APP210	63/A	HSK63/A DIN69893 P/P H100 ER16	16	32	100	●
66APP213	63/A	HSK63/A DIN69893 P/P H100 ER20	20	35	100	●
66APP216	63/A	HSK63/A DIN69893 P/P H100 ER25	25	42	100	●
66APP220	63/A	HSK63/A DIN69893 P/P H100 ER32	32	50	100	●
66APP226	63/A	HSK63/A DIN69893 P/P H100 ER40	40	63	100	●

**COMPONENTI - SPARE PARTS - PIECES DETACHEES - ERSATZTEILE**

ER	Ghiera	Q.tà	Ghiera Interna	Q.tà
				
16	916GHREQ	1	101001601	1
20	920GHREQ	1	101001601	1
25	925GHREQ	1	101815801	1
32	932GHREQ	1	102215901	1
40	940GHREQ	1	102215901	1

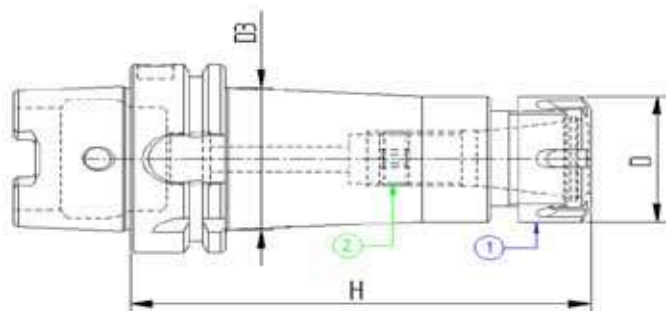

**L=120**

Codice	HSK	Descrizione	ER	D	D3	H	G6.3 15000
66APP310	63/A	HSK63/A DIN69893 P/P H120 ER16	16	32	-	120	●
66APP313	63/A	HSK63/A DIN69893 P/P H120 ER20	20	35	-	120	●
66APP316	63/A	HSK63/A DIN69893 P/P H120 ER25	25	42	-	120	●
66APP320	63/A	HSK63/A DIN69893 P/P H120 ER32	32	50	-	120	●
66APP326	63/A	HSK63/A DIN69893 P/P H120 ER40	40	63	50	120	●

**L=160**

Codice	HSK	Descrizione	ER	D	D3	H	G6.3 15000
66APP410	63/A	HSK63/A DIN69893 P/P H160 ER16	16	32	38	160	●
66APP413	63/A	HSK63/A DIN69893 P/P H160 ER20	20	35	42	160	●
66APP416	63/A	HSK63/A DIN69893 P/P H160 ER25	25	42	48	160	●
66APP420	63/A	HSK63/A DIN69893 P/P H160 ER32	32	50	50	160	●
66APP426	63/A	HSK63/A DIN69893 P/P H160 ER40	40	63	50	160	●

**L=200**

Codice	HSK	Descrizione	ER	D	D3	H	G6.3 15000
66APP510	63/A	HSK63/A DIN69893 P/P H200 ER16	16	32	40	200	●
66APP513	63/A	HSK63/A DIN69893 P/P H200 ER20	20	35	44	200	●
66APP516	63/A	HSK63/A DIN69893 P/P H200 ER25	25	42	50	200	●
66APP520	63/A	HSK63/A DIN69893 P/P H200 ER32	32	50	50	200	●
66APP526	63/A	HSK63/A DIN69893 P/P H200 ER40	40	63	50	200	●

**COMPONENTI - SPARE PARTS - PIECES DETACHEES - ERSATZTEILE**

ER	Ghiera	Q.tà	Ghiera Interna	Q.tà
----	--------	------	----------------	------



16	916GHREQ	1	101001601	1
20	920GHREQ	1	101001601	1
25	925GHREQ	1	101815801	1
32	932GHREQ	1	102215901	1
40	940GHREQ	1	102215901	1



**FIG. 1**

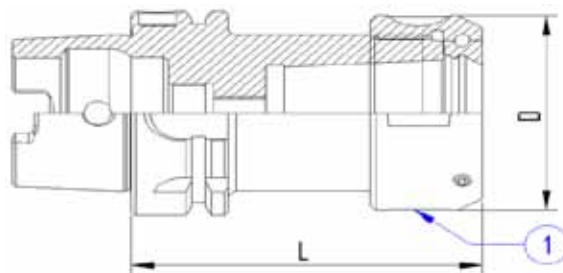

**FIG. 2**

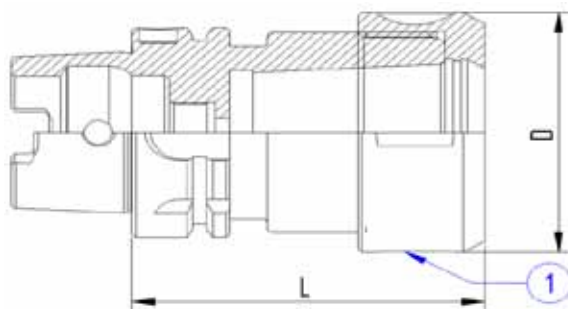

Codice	HSK	Descrizione	EOC	D	L	Fig.	G6.3 15000
66APO216	63/A	HSK63/A DIN69893 P/P H100 EOC16	16	43	100	1	●
66APO225	63/A	HSK63/A DIN69893 P/P H100 EOC25	25	60	100	1	●
66APO232	63/A	HSK63/A DIN69893 P/P H120 EOC32	32	72	120	2	●
66APO416	63/A	HSK63/A DIN69893 P/P H160 EOC16	16	43	160	1	●
66APO425	63/A	HSK63/A DIN69893 P/P H160 EOC25	25	60	160	1	●
66APO432	63/A	HSK63/A DIN69893 P/P H160 EOC32	32	72	160	2	●

**COMPONENTI - SPARE PARTS - PIECES DETACHEES - ERSATZTEILE**

EOC	L	Ghiera	Q.tà	Grano	Q.tà
-----	---	--------	------	-------	------



16	100	916GHROS	1	101001601	1
25	100	925GHROS	1	101001601	1
32	100	932GHROS	1	101001601	1
16	160	916GHROS	1	101815801	1
25	160	925GHROS	1	102215901	1
32	160	932GHROS	1	102215901	1

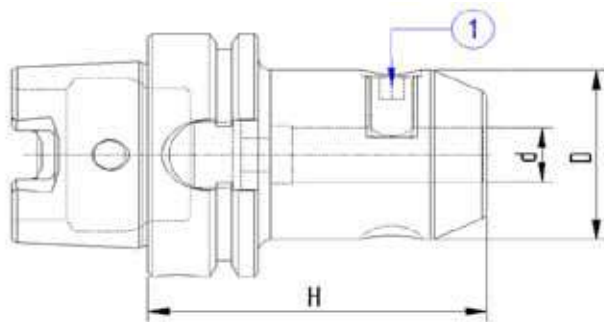

Codice	HSK	Descrizione	d	D	H	G6.3 15000
66AWLD06	63/A	HSK63/A DIN69893 WELDON H65 D.06	6	25	65	●
66AWLD08	63/A	HSK63/A DIN69893 WELDON H65 D.08	8	28	65	●
66AWLD10	63/A	HSK63/A DIN69893 WELDON H65 D.10	10	35	65	●
66AWLD12	63/A	HSK63/A DIN69893 WELDON H80 D.12	12	42	80	●
66AWLD14	63/A	HSK63/A DIN69893 WELDON H80 D.14	14	44	80	●
66AWLD16	63/A	HSK63/A DIN69893 WELDON H80 D.16	16	48	80	●
66AWLD18	63/A	HSK63/A DIN69893 WELDON H80 D.18	18	50	80	●
66AWLD20	63/A	HSK63/A DIN69893 WELDON H80 D.20	20	52	80	●
66AWLD24	63/A	HSK63/A DIN69893 WELDON H100 D.24	24	63	100	●
66AWLD25	63/A	HSK63/A DIN69893 WELDON H110 D.25	25	65	110	●
66AWLD32	63/A	HSK63/A DIN69893 WELDON H110 D.32	32	72	110	●
66AWLD40	63/A	HSK63/A DIN69893 WELDON H125 D.40	40	80	125	●

**COMPONENTI - SPARE PARTS - PIECES DETACHEES - ERSATZTEILE**

Ø WLD	Grano	Q.tà
-------	-------	------



**1**

6	100601002	1
8	100801002	1
10	101001202	1
12 - 14	101201602	1
16 - 18	101401602	1
20	101601602	1
24	101802002	2
25	101802002	2
32 - 40	102002002	2



MANDRINO PORTAFRESE TIPO WELDON  
 END MILL HOLDERS WELDON  
 MANDRINS POUR OUTIL TYPE WELDON  
 ZYLINDERSCHAFTAUFNAHME WELDON



**DIN 69893**

**DIN 1835 B**

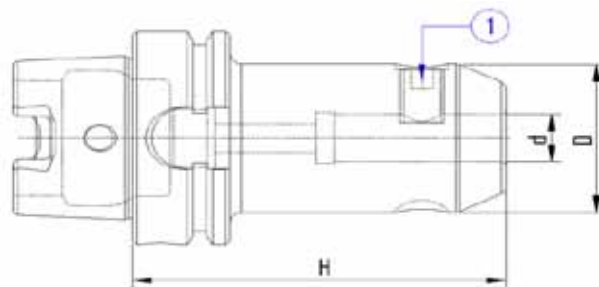

Codice	HSK	Descrizione	d	D	H	G6.3 15000
66AWE206	63/A	HSK63/A DIN69893 WELDON H.100 D.6	6	25	100	●
66AWE208	63/A	HSK63/A DIN69893 WELDON H.100 D.8	8	28	100	●
66AWE210	63/A	HSK63/A DIN69893 WELDON H.100 D.10	10	35	100	●
66AWE212	63/A	HSK63/A DIN69893 WELDON H.100 D.12	12	42	100	●
66AWE214	63/A	HSK63/A DIN69893 WELDON H.100 D.14	14	44	100	●
66AWE216	63/A	HSK63/A DIN69893 WELDON H.100 D.16	16	48	100	●
66AWE218	63/A	HSK63/A DIN69893 WELDON H.100 D.18	18	50	100	●
66AWE220	63/A	HSK63/A DIN69893 WELDON H.100 D.20	20	52	100	●

**COMPONENTI - SPARE PARTS - PIECES DETACHEES - ERSATZTEILE**

Ø WLD	Grano	Q.tà
-------	-------	------



6	100601002	1
8	100801002	1
10	101001202	1
12 - 14	101201602	1
16 - 18	101401602	1
20	101601602	1



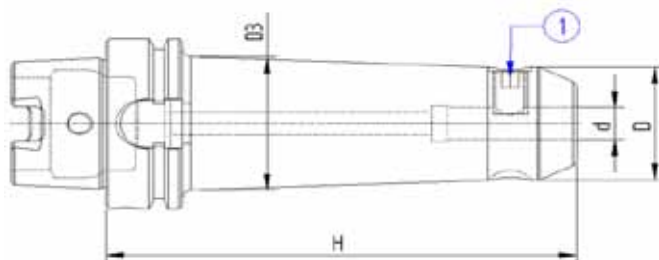

Codice	HSK	Descrizione	d	D	H	D3	G6.3 15000
66AWE306	63/A	HSK63/A DIN69893 WELDON H.120 D.6	6	25	120	-	●
66AWE308	63/A	HSK63/A DIN69893 WELDON H.120 D.8	8	28	120	-	●
66AWE310	63/A	HSK63/A DIN69893 WELDON H.120 D.10	10	35	120	-	●
66AWE312	63/A	HSK63/A DIN69893 WELDON H.120 D.12	12	42	120	-	●
66AWE314	63/A	HSK63/A DIN69893 WELDON H.120 D.14	14	44	120	-	●
66AWE316	63/A	HSK63/A DIN69893 WELDON H.120 D.16	16	48	120	-	●
66AWE318	63/A	HSK63/A DIN69893 WELDON H.120 D.18	18	50	120	-	●
66AWE320	63/A	HSK63/A DIN69893 WELDON H.120 D.20	20	52	120	-	●
66AWE325	63/A	HSK63/A DIN69893 WELDON H.120 D.25	25	65	120	52	●
66AWE332	63/A	HSK63/A DIN69893 WELDON H.120 D.32	32	72	120	52	●

**COMPONENTI - SPARE PARTS - PIECES DETACHEES - ERSATZTEILE**

Ø WLD	Grano	Q.tà
-------	-------	------



6	100601002	1
8	100801002	1
10	101001202	1
12 - 14	101201602	1
16 - 18	101401602	1
20	101601602	1
25	101802002	2
32	102002002	2



MANDRINO PORTAFRESE TIPO WELDON  
 END MILL HOLDERS WELDON  
 MANDRINS POUR OUTIL TYPE WELDON  
 ZYLINDERSCHAFTAUFNAHME WELDON



**DIN 69893**

**DIN 1835 B**

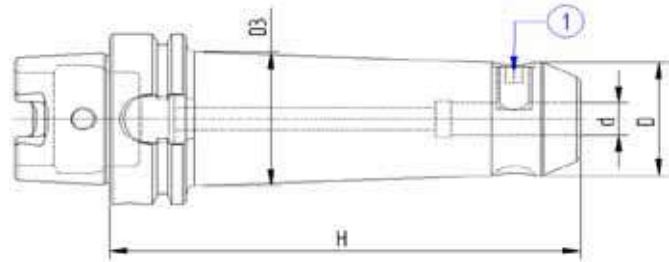

Codice	HSK	Descrizione	d	D	H	D3	G6.3 15000
66AWE406	63/A	HSK63/A DIN69893 WELDON H.160 D.6	6	25	160	32	●
66AWE408	63/A	HSK63/A DIN69893 WELDON H.160 D.8	8	28	160	36	●
66AWE410	63/A	HSK63/A DIN69893 WELDON H.160 D.10	10	35	160	38	●
66AWE412	63/A	HSK63/A DIN69893 WELDON H.160 D.12	12	42	160	46	●
66AWE414	63/A	HSK63/A DIN69893 WELDON H.160 D.14	14	44	160	48	●
66AWE416	63/A	HSK63/A DIN69893 WELDON H.160 D.16	16	44	160	50	●
66AWE418	63/A	HSK63/A DIN69893 WELDON H.160 D.18	18	50	160	-	●
66AWE420	63/A	HSK63/A DIN69893 WELDON H.160 D.20	20	52	160	-	●
66AWE425	63/A	HSK63/A DIN69893 WELDON H.160 D.25	25	63	160	52	●
66AWE432	63/A	HSK63/A DIN69893 WELDON H.160 D.32	32	72	160	52	●
66AWE440	63/A	HSK63/A DIN69893 WELDON H.160 D.40	40	80	160	52	●

**COMPONENTI - SPARE PARTS - PIECES DETACHEES - ERSATZTEILE**

Ø WLD	Grano	Q.tà
-------	-------	------



6	100601002	1
8	100801002	1
10	101001202	1
12 - 14	101201602	1
16 - 18	101401602	1
20	101601602	1
25	101802002	2
32 - 40	102002002	2

**MANDRINO PORTAFRESE TIPO WELDON CON CANALI DI LUBRIFICAZIONE**  
**END MILL HOLDERS WELDON WITH COOLANT CHANNELS**  
**MANDRINS POUR OUTIL TYPE WELDON AVEC CANAL D'ARROSAGE**  
**ZYLINDERSCHAFTAUFNAHME WELDON MIT KÜHLKANAL**



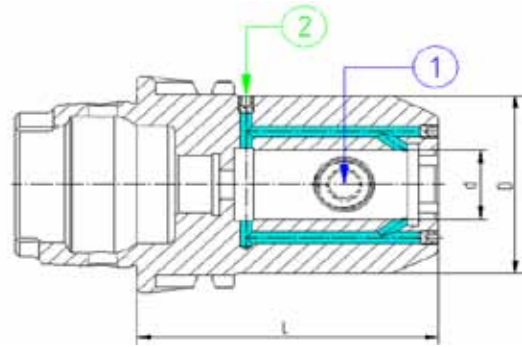

**DIN 69893**  
**DIN 1835 B**



Codice	HSK	Descrizione	d	D	L	G6.3 15000
66AWLK06	63/A	HSK63/A DIN69893 WELDON/C H65 D.6	6	25	65	●
66AWLK08	63/A	HSK63/A DIN69893 WELDON/C H65 D.8	8	28	65	●
66AWLK10	63/A	HSK63/A DIN69893 WELDON/C H65 D.10	10	35	65	●
66AWLK12	63/A	HSK63/A DIN69893 WELDON/C H80 D.12	12	42	80	●
66AWLK14	63/A	HSK63/A DIN69893 WELDON/C H80 D.14	14	44	80	●
66AWLK16	63/A	HSK63/A DIN69893 WELDON/C H80 D.16	16	48	80	●
66AWLK18	63/A	HSK63/A DIN69893 WELDON/C H80 D.18	18	50	80	●
66AWLK20	63/A	HSK63/A DIN69893 WELDON/C H80 D.20	20	52	80	●
66AWLK25	63/A	HSK63/A DIN69893 WELDON/C H110 D.25	25	65	110	●
66AWLK32	63/A	HSK63/A DIN69893 WELDON/C H110 D.32	32	72	110	●
66AWLK40	63/A	HSK63/A DIN69893 WELDON/C H125 D.40	40	80	125	●

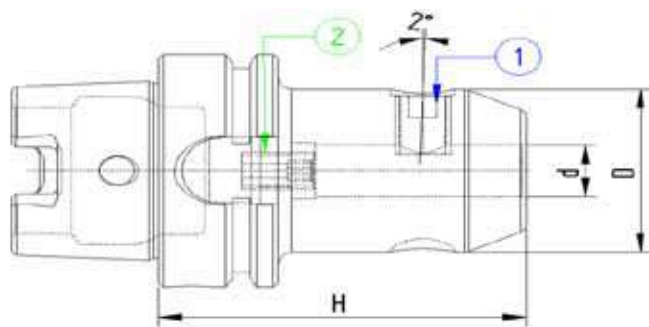

**COMPONENTI - SPARE PARTS - PIECES DETACHEES - ERSATZTEILE**

Ø WLD	Grano	Q.tà	Grano	Q.tà
		<b>1</b>		<b>2</b>
				
6	100601002	1	100400404	2
8	100801002	1	100400504	2
10	101001202	1	100400504	2
12 - 14	101201602	1	100400504	2
16 - 18	101401602	1	100400504	3
20	101601602	1	100400504	3
25	101802002	2	100400504	3
32 - 40	102002002	2	100400504	3



Codice	HSK	Descrizione	d	D	H	G6.3 15000
66AWHN06	63/A	HSK63/A DIN69893 W/NOTCH H.80 D.06	6	25	80	●
66AWHN08	63/A	HSK63/A DIN69893 W/NOTCH H.80 D.08	8	28	80	●
66AWHN10	63/A	HSK63/A DIN69893 W/NOTCH H.80 D.10	10	35	80	●
66AWHN12	63/A	HSK63/A DIN69893 W/NOTCH H.90 D.12	12	42	90	●
66AWHN14	63/A	HSK63/A DIN69893 W/NOTCH H.90 D.14	14	44	90	●
66AWHN16	63/A	HSK63/A DIN69893 W/NOTCH H.100 D.16	16	48	100	●
66AWHN18	63/A	HSK63/A DIN69893 W/NOTCH H.100 D.18	18	50	100	●
66AWHN20	63/A	HSK63/A DIN69893 W/NOTCH H.100 D.20	20	52	100	●
66AWHN25	63/A	HSK63/A DIN69893 W/NOTCH H.110 D.25	25	63	110	●
66AWHN32	63/A	HSK63/A DIN69893 W/NOTCH H.110 D.32	32	72	110	●

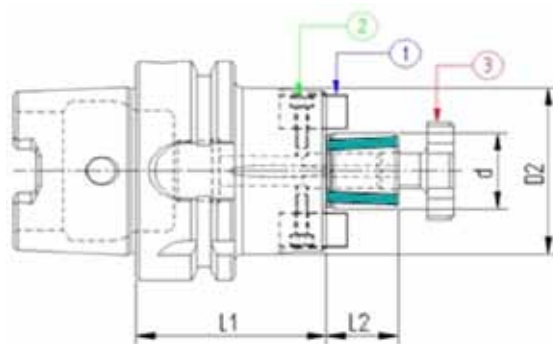

**COMPONENTI - SPARE PARTS - PIECES DETACHEES - ERSATZTEILE**

Ø WLD	Grano	Q.tà	Grano Interno	Q.tà
		<b>1</b>		<b>2</b>
				
6	100601002	1	100501601	1
8	100801002	1	100601601	1
10	101001202	1	100801601	1
12 - 14	101201602	1	101001601	1
16 - 18	101401602	1	101001601	1
20	101601602	1	101002501	1
25	101802002	2	101002501	1
32	102002002	2	101001601	1



Codice	HSK	Descrizione	d	L1	L2	D2	G6.3 15000
66APF116	63/A	HSK63/A DIN69893 P/F FISSO H50 D.16	16	50	17	38	●
66APF122	63/A	HSK63/A DIN69893 P/F FISSO H50 D.22	22	50	19	48	●
66APF127	63/A	HSK63/A DIN69893 P/F FISSO H60 D.27	27	60	21	58	●
66APF132	63/A	HSK63/A DIN69893 P/F FISSO H60 D.32	32	60	24	66	●
66APF140	63/A	HSK63/A DIN69893 P/F FISSO H60 D.40	40	60	27	80	●

**COMPONENTI - SPARE PARTS - PIECES DETACHEES - ERSATZTEILE**

d / D2	Tassello	Q.tà	Vite	Q.tà	Vite a Croce	Q.tà
						
	<b>1</b>		<b>2</b>		<b>3</b>	
16 / 38	916TSL01	2	110301001	2	916VTC02	1
22 / 48	922TSL01	2	110301201	2	922VTC02	1
27 / 58	927TSL01	2	110401601	2	927VTC02	1
32 / 66	932TSL01	2	110601601	2	932VTC02	1
40 / 80	940TSL01	2	110601601	2	940VTC02	1



**L=100**

Codice	HSK	Descrizione	d	L	L1	D	G6.3 15000
66APF216	63/A	HSK63/A DIN69893 P/F FISSO H100 D16	16	100	17	38	●
66APF222	63/A	HSK63/A DIN69893 P/F FISSO H100 D22	22	100	19	48	●
66APF227	63/A	HSK63/A DIN69893 P/F FISSO H100 D27	27	100	21	58	●
66APF232	63/A	HSK63/A DIN69893 P/F FISSO H100 D32	32	100	24	66	●
66APF240	63/A	HSK63/A DIN69893 P/F FISSO H100 D40	40	100	27	80	●

**L=160**

Codice	HSK	Descrizione	d	L	L1	D	G6.3 15000
66APF416	63/A	HSK63/A DIN69893 P/F FISSO H160 D16	16	160	17	38	●
66APF422	63/A	HSK63/A DIN69893 P/F FISSO H160 D22	22	160	19	48	●
66APF427	63/A	HSK63/A DIN69893 P/F FISSO H160 D27	27	160	21	58	●
66APF432	63/A	HSK63/A DIN69893 P/F FISSO H160 D32	32	160	24	66	●
66APF440	63/A	HSK63/A DIN69893 P/F FISSO H160 D40	40	160	27	80	●

**COMPONENTI - SPARE PARTS - PIECES DETACHEES - ERSATZTEILE**

d / D	Tassello	Q.tà	Vite	Q.tà	Vite a Croce	Q.tà
-------	----------	------	------	------	--------------	------

**1**



**2**



**3**



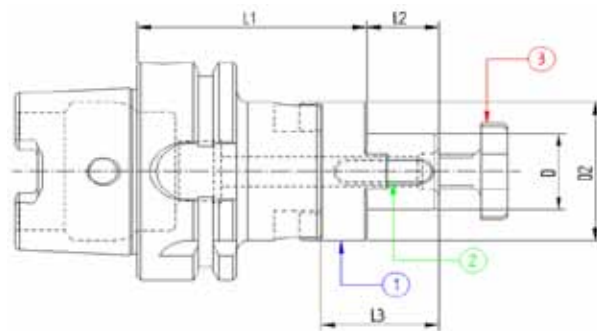

16 / 38	916TSL01	2	110301001	2	916VTC02	1
22 / 48	922TSL01	2	110301201	2	922VTC02	1
27 / 58	927TSL01	2	110401601	2	927VTC02	1
32 / 66	932TSL01	2	110601601	2	932VTC02	1
40 / 80	940TSL01	2	110601601	2	940VTC02	1



Codice	HSK	Descrizione	D	L1	L2	L3	D2
66APU116	63/A	HSK63/A DIN69893 P/F UNIV.H60 D16	16	60	17	27	32
66APU122	63/A	HSK63/A DIN69893 P/F UNIV.H60 D22	22	60	19	31	40
66APU127	63/A	HSK63/A DIN69893 P/F UNIV.H60 D27	27	60	21	33	48
66APU132	63/A	HSK63/A DIN69893 P/F UNIV.H60 D32	32	60	24	38	58
66APU140	63/A	HSK63/A DIN69893 P/F UNIV.H70 D40	40	70	27	41	70

**COMPONENTI - SPARE PARTS - PIECES DETACHEES - ERSATZTEILE**

Ø	Giunto	Q.tà	Linguetta	Q.tà	Vite a Croce	Q.tà
						
	<b>1</b>		<b>2</b>		<b>3</b>	
16	916GNT01	1	170402004	1	916VTC02	1
22	922GNT01	1	170602506	1	922VTC02	1
27	927GNT01	1	170702507	1	927VTC02	1
32	932GNT01	1	170802807	1	932VTC02	1
40	940GNT01	1	171003208	1	940VTC02	1

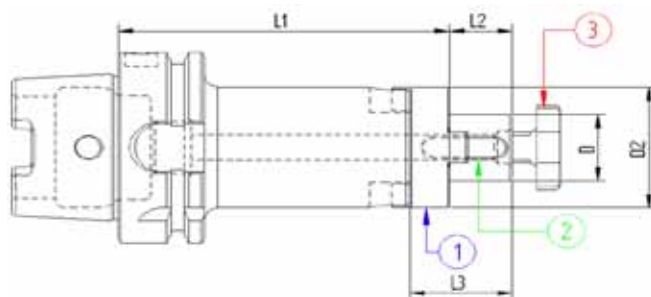



**L=100**

Codice	HSK	Descrizione	D	L1	L2	L3	D2
66APU216	63/A	HSK63/A DIN69893 P/F UNIV. H100 D16	16	100	17	27	32
66APU222	63/A	HSK63/A DIN69893 P/F UNIV. H100 D22	22	100	19	31	40
66APU227	63/A	HSK63/A DIN69893 P/F UNIV. H100 D27	27	100	21	33	48
66APU232	63/A	HSK63/A DIN69893 P/F UNIV. H100 D32	32	100	24	38	58
66APU240	63/A	HSK63/A DIN69893 P/F UNIV. H100 D40	40	100	27	41	70

**L=160**

Codice	HSK	Descrizione	D	L1	L2	L3	D2
66APU416	63/A	HSK63/A DIN69893 P/F UNIV.H160 D16	16	160	17	27	32
66APU422	63/A	HSK63/A DIN69893 P/F UNIV.H160 D22	22	160	19	31	40
66APU427	63/A	HSK63/A DIN69893 P/F UNIV.H160 D27	27	160	21	33	48
66APU432	63/A	HSK63/A DIN69893 P/F UNIV.H160 D32	32	160	24	38	58
66APU440	63/A	HSK63/A DIN69893 P/F UNIV.H160 D40	40	160	27	41	70

**COMPONENTI - SPARE PARTS - PIECES DETACHEES - ERSATZTEILE**

Ø	Giunto	Q.tà	Linguetta	Q.tà	Vite a Croce	Q.tà
						
16	916GNT01	1	170402004	1	916VTC02	1
22	922GNT01	1	170602506	1	922VTC02	1
27	927GNT01	1	170702507	1	927VTC02	1
32	932GNT01	1	170802807	1	932VTC02	1
40	940GNT01	1	171003208	1	940VTC02	1





**MANDRINI ATTACCO CONO MORSE PER PUNTE**  
**MORSE TAPER ADAPTORS FOR DRILL**  
**DOUILLES POUR CONE MORSE A TENON**  
**ZWINSCHENHULSEN FÜR MORSEKEGEL MIT AUSTREIBLAPPEN**

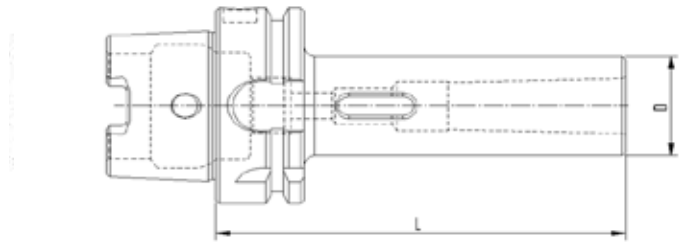

**DIN 69893**

**DIN 228 - 2**



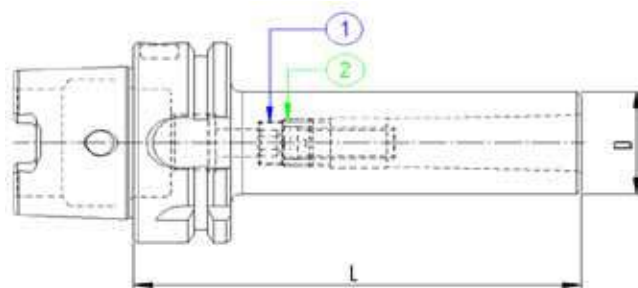

<b>Codice</b>	<b>HSK</b>	<b>Descrizione</b>	<b>MORSE</b>	<b>D</b>	<b>L</b>
66AMP101	63/A	HSK63/A DIN69893 H100 CM1 PUNTE	1	25	100
66AMP102	63/A	HSK63/A DIN69893 H120 CM2 PUNTE	2	32	120
66AMP103	63/A	HSK63/A DIN69893 H140 CM3 PUNTE	3	40	140
66AMP104	63/A	HSK63/A DIN69893 H160 CM4 PUNTE	4	48	160



<b>Codice</b>	<b>HSK</b>	<b>Descrizione</b>	<b>MORSE</b>	<b>D</b>	<b>L</b>
66AMF101	63/A	HSK63/A DIN69893 H100 CM1 FRESE	1	25	100
66AMF102	63/A	HSK63/A DIN69893 H120 CM2 FRESE	2	32	120
66AMF103	63/A	HSK63/A DIN69893 H140 CM3 FRESE	3	40	140
66AMF104	63/A	HSK63/A DIN69893 H160 CM4 FRESE	4	48	160

**COMPONENTI - SPARE PARTS - PIECES DETACHEES - ERSATZTEILE**

<b>HSK</b>	<b>Vite</b>	<b>Q.tà</b>	<b>Boccola</b>	<b>Q.tà</b>
				
	<b>1</b>		<b>2</b>	
CM1	110603001	1	-	1
CM2	111003014	1	121500802	1
CM3	111204003	1	122000903	1
CM4	111604516	1	122501204	1

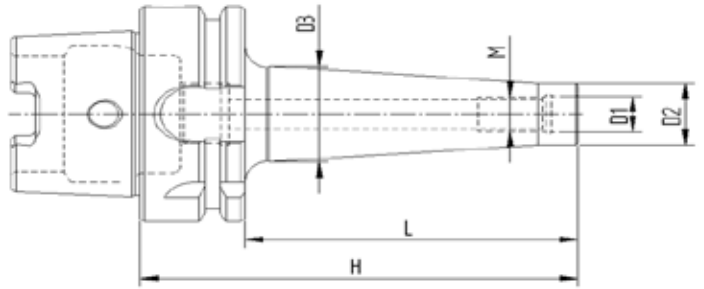

**L = 59**

Codice	HSK	Descrizione	D1	D2	D3	H	L	M	G2.5 20000
66AAF108	63/A	HSK63/A DIN69893 P/F AT.FIL.M8x59	8.5	13	15	59	33	M8	●
66AAF110	63/A	HSK63/A DIN69893 P/F AT.FIL.M10x59	10.5	18	19.5	59	33	M10	●
66AAF112	63/A	HSK63/A DIN69893 P/F AT.FIL.M12x59	12.5	21	24	59	33	M12	●
66AAF116	63/A	HSK63/A DIN69893 P/F AT.FIL.M16x59	17	29	34	59	33	M16	●

**L = 84**

Codice	HSK	Descrizione	D1	D2	D3	H	L	M	G2.5 20000
66AAF208	63/A	HSK63/A DIN69893 P/F AT.FIL.M8x84	8.5	13	23	84	58	M8	●
66AAF210	63/A	HSK63/A DIN69893 P/F AT.FIL.M10x84	10.5	18	25	84	58	M10	●
66AAF212	63/A	HSK63/A DIN69893 P/F AT.FIL.M12x84	12.5	21	24	84	58	M12	●
66AAF216	63/A	HSK63/A DIN69893 P/F AT.FIL.M16x84	17	29	34	84	58	M16	●

**L = 109**

Codice	HSK	Descrizione	D1	D2	D3	H	L	M	G2.5 20000
66AAF308	63/A	HSK63/A DIN69893 P/F AT.FIL.M8x109	8.5	13	23	109	83	M8	●
66AAF310	63/A	HSK63/A DIN69893 P/F AT.FIL.M10x109	10.5	18	28	109	83	M10	●
66AAF312	63/A	HSK63/A DIN69893 P/F AT.FIL.M12x109	12.5	21	31	109	83	M12	●
66AAF316	63/A	HSK63/A DIN69893 P/F AT.FIL.M16x109	17	29	34	109	83	M16	●

**L = 134**

Codice	HSK	Descrizione	D1	D2	D3	H	L	M	G2.5 20000
66AAF408	63/A	HSK63/A DIN69893 P/F AT.FIL.M8x134	8.5	13	25	134	108	M8	●
66AAF410	63/A	HSK63/A DIN69893 P/F AT.FIL.M10x134	10.5	18	28	134	108	M10	●
66AAF412	63/A	HSK63/A DIN69893 P/F AT.FIL.M12x134	12.5	21	31	134	108	M12	●
66AAF416	63/A	HSK63/A DIN69893 P/F AT.FIL.M16x134	17	29	39	134	108	M16	●



MANDRINI PER FRESE CON ATTACCO FILETTATO  
MILLING CUTTER ARBORS FOR SCREW-ON TYPE MILLING CUTTERS  
MANDRINS POUR FRAISES A VISSER  
SPANFUTTER FUER EIN SCHRAUBFRAESER



**DIN 69893**

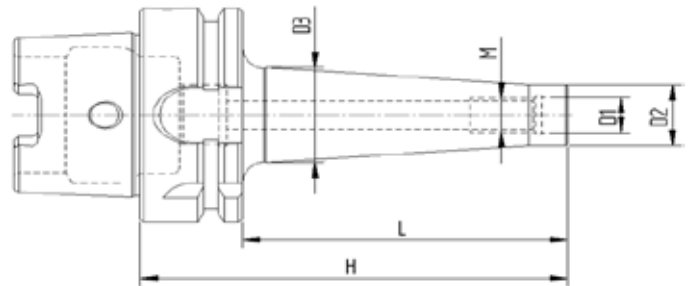

**L = 159**

Codice	HSK	Descrizione	D1	D2	D3	H	L	M	G2.5 20000
66AAF510	63/A	HSK63/A DIN69893 P/F AT.FIL.M10x159	10.5	18	34	159	133	M10	●
66AAF512	63/A	HSK63/A DIN69893 P/F AT.FIL.M12x159	12.5	21	31	159	133	M12	●
66AAF516	63/A	HSK63/A DIN69893 P/F AT.FIL.M16x159	17	29	39	159	133	M16	●

**L = 184**

Codice	HSK	Descrizione	D1	D2	D3	H	L	M	G2.5 20000
66AAF612	63/A	HSK63/A DIN69893 P/F AT.FIL.M12x184	12.5	21	39	184	158	M12	●
66AAF616	63/A	HSK63/A DIN69893 P/F AT.FIL.M16x184	17	29	39	184	158	M16	●

**L = 209**

Codice	HSK	Descrizione	D1	D2	D3	H	L	M	G2.5 20000
66AAF712	63/A	HSK63/A DIN69893 P/F AT.FIL.M12x209	12.5	21	42	209	183	M12	●
66AAF716	63/A	HSK63/A DIN69893 P/F AT.FIL.M16x209	17	29	42	209	183	M16	●

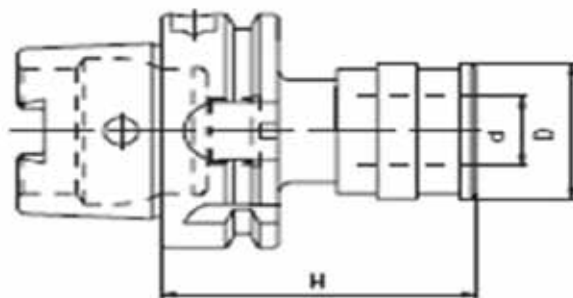

Codice	HSK	Descrizione	H	D	d
66APCRM1	63/A	HSK63/A M/PORTAM/C/R H72 GR.1	72	48	19
66APCRM2	63/A	HSK63/A M/PORTAM/C/R H110 GR.2	110	60	31

**ACCESSORI - ACCESSORIES - ACCESSIRES - ZUBEHOR**



RIF. PAGINA **312**



RIF. PAGINA **313**

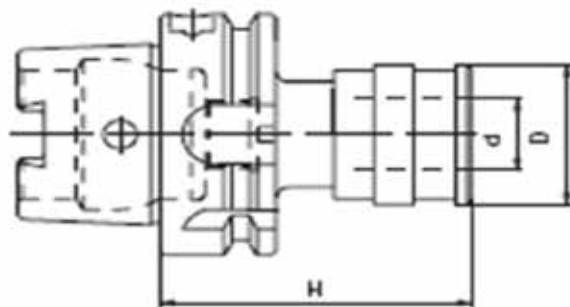

Codice	HSK	Descrizione	H	D	d
66APRRM1	63/A	HSK63/A M/PORTAM/C/R/R H72 GR.1	72	33	19
66APRRM2	63/A	HSK63/A M/PORTAM/C/R/R H110 GR.2	110	50	31

**ACCESSORI - ACCESSORIES - ACCESSOIRES - ZUBEHÖR**



RIF. PAGINA **312**



RIF. PAGINA **313**

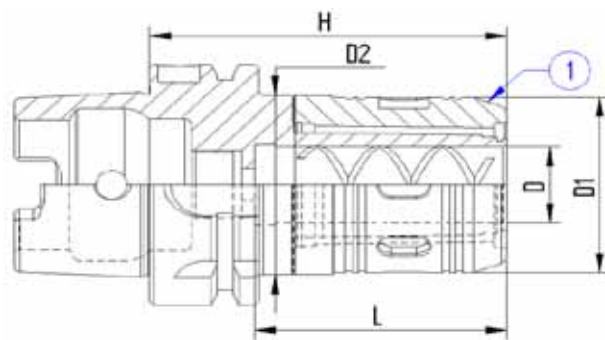

Codice	HSK	Descrizione	H	D	D1	D2	L	G6.3 12000
66AFS120	63/A	HSK 63/A FORTE SERRAGGIO Ø20 H85	85	20	46	47	60	●
66AFS232	63/A	HSK 63/A FORTE SERRAGGIO Ø32 H110	110	32	62	63	84	●

**ACCESSORI - ACCESSORIES - ACCESSOIRES - ZUBEHÖR**



RIF. PAGINA **315**

**MANDRINI INTEGRALI CON CHIAVE ESAGONALE**  
**DRILL CHUCK WITH EXAG-KEY LOCK SYSTEM**  
**MANDRINS MONOBLOC-SERRAGE PAR CLE 6 PANS**  
**NC-KURZBOHRFUTTER-SPANNEN DURCH 6 - KANTSCHLUSSEL**



**DIN 69893**

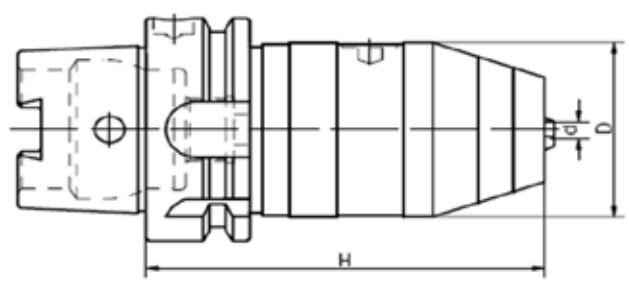

**CON REFRIGERANTE CENTRALE - WITH INTERNAL COOLANT SUPPLY - AVEC ARROSAGE INTERNE - MIT ZENTRALEM KUHLMITTELLOCH**

<b>Codice</b>	<b>HSK</b>	<b>Descrizione</b>	<b>H</b>	<b>D</b>	<b>d</b>
66AMAZ13	63/A	HSK63/A M/AUTOS./FORI H100 D13	100	50	1 - 13
66AMAZ16	63/A	HSK63/A M/AUTOS./FORI H105 D16	105	50	3 - 16



**MANDRINI SEMILAVORATI A STELO TENERO**  
**BLANK TOOLHOLDER WITH SOFT SHANK**  
**BARRES D'ALEPAGE SEMI-FINIES**  
**ROHLINGE MIT WEICHEM SCHAFT**



**DIN 69893**



<b>Codice</b>	<b>HSK</b>	<b>Descrizione</b>	<b>D</b>	<b>L</b>
66AST363	63/A	HSK63/A DIN69893 ST.TENERO D.63x250	63	250
66AST380	63/A	HSK63/A DIN69893 ST.TENERO D.80x250	80	250